

**University of Victoria
Department of Music
BUCHLA 200-series
MODULAR SYNTHESIZER**

AUTHOR: _____
 PATCH: _____
 DATE: _____

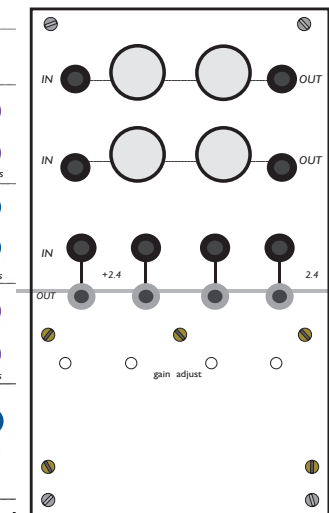
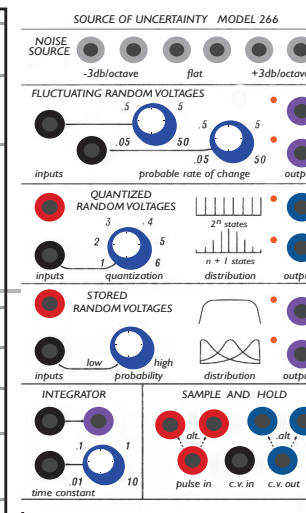
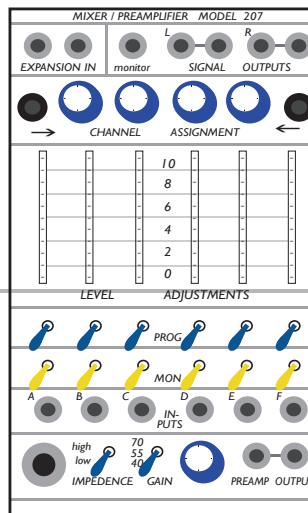
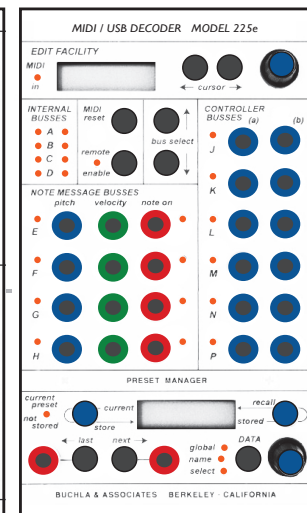
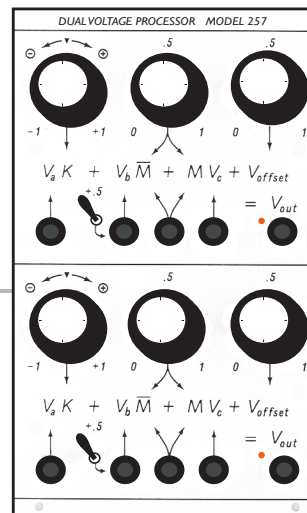
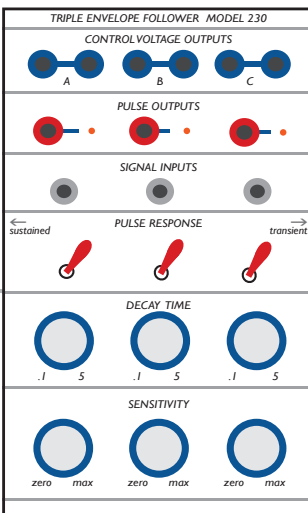
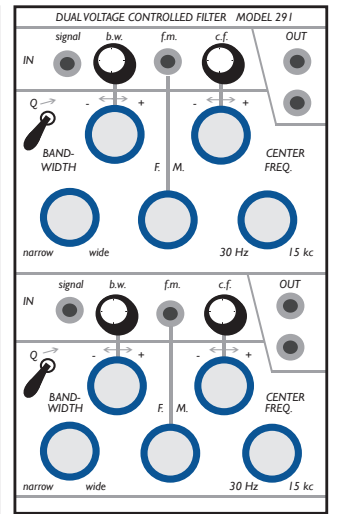
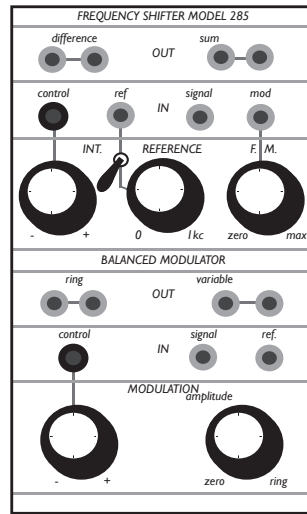
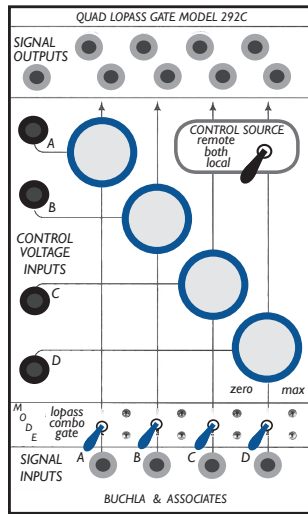
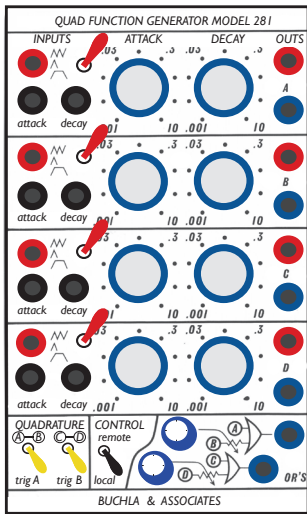
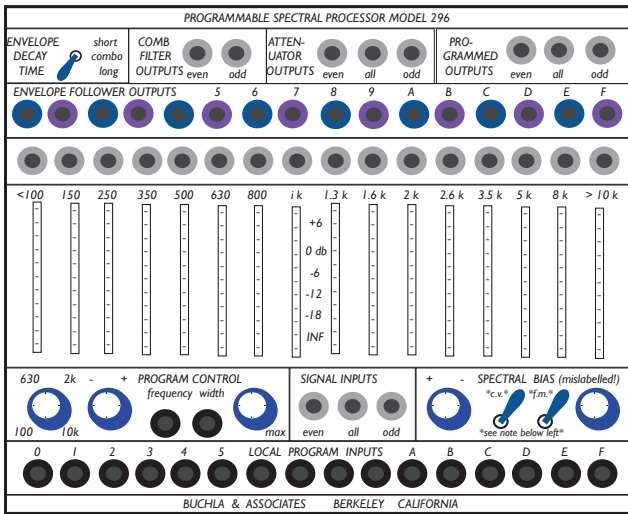
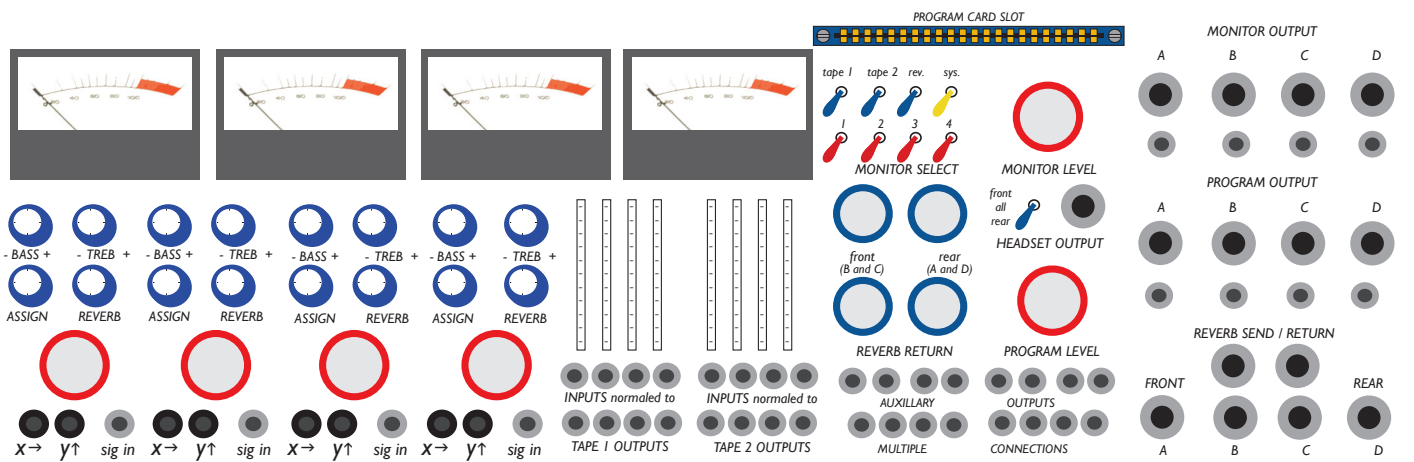

FOLD HERE

Programmable Spectral Processor Model 296 - bottom right mislabelled
 PROGRAMMABLE SPECTRUM TRANSFER
 even pre-amp, odd pre-amp
 Newer versions of the 200-series show the correct panel labelling in the bottom-right corner of Model 296. The Uvic Buchla Manual (Section 5.5.4 on p. 25 of the D. Schaefer 1981 User Guide) addresses this issue and details how the controls actually work.

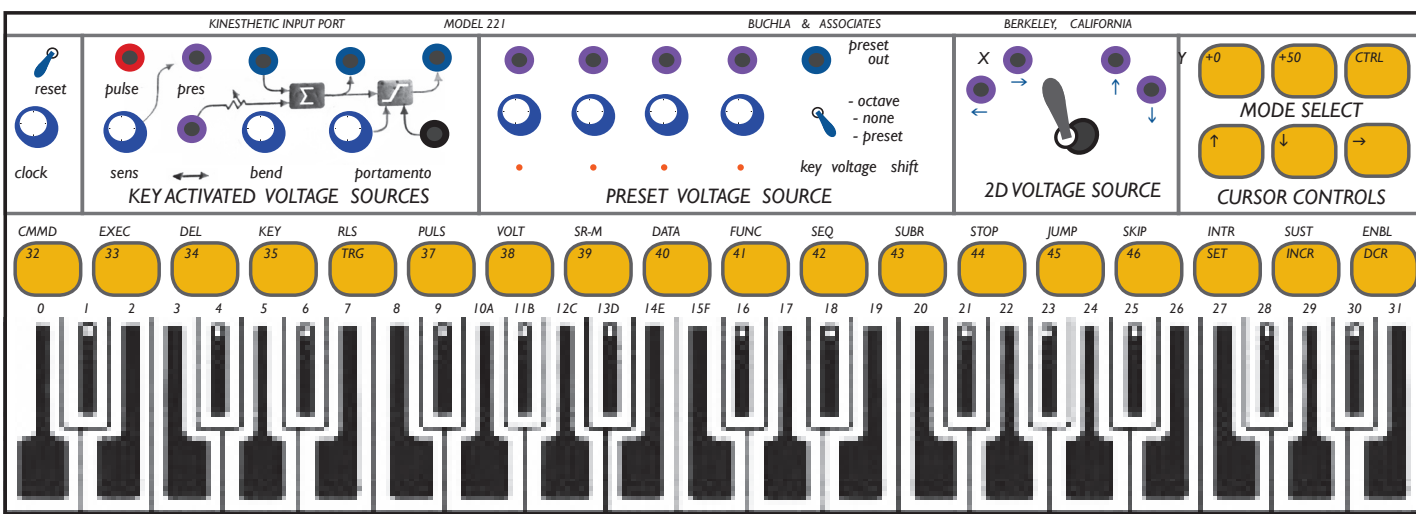
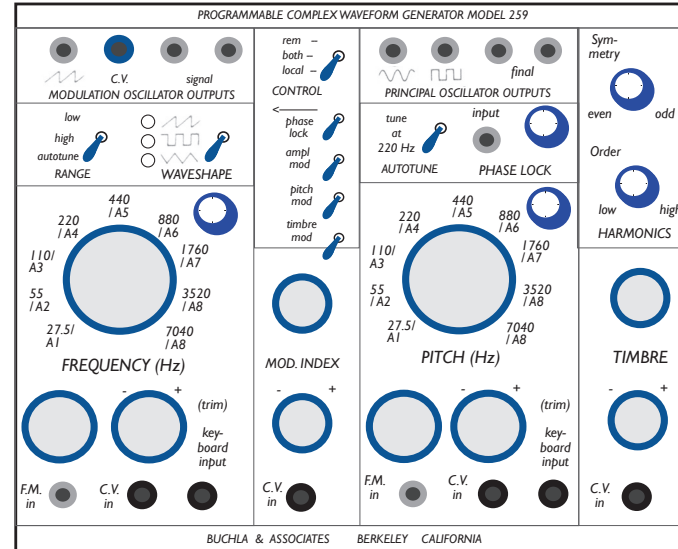
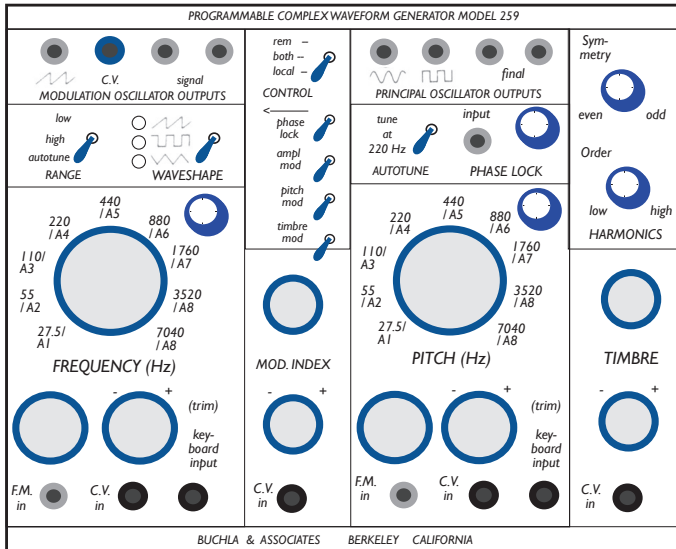

TRIM HERE

This template prints out on 17x11 (Tabloid Size) paper. For binding, punch the top of the template for a regular binder for 8.5x11 (Letter Size) paper. Trim along the line above this instruction and fold where indicated above.